

OLYMPUS[®]

Your Vision, Our Future

Stereo Microscope System

SZX7/SZ61/SZ51

For Industrial Use

Comfort and Precision in Industrial Applications



Comfort for Your Eyes—Precision for Your Work

Using a microscope for a long period of time can cause eyes to become fatigued. Olympus redesigned the SZ series of stereo zoom microscopes to reduce eyestrain and maximize user comfort.

Less fatigue and eyestrain leads to more precise and consistent results in an operator's daily work.

All three models—the SZX7 with its advanced Galilean optical system, the full-featured SZ61, and the versatile SZ51—are designed for user comfort and provide 3D images with true color, high resolution, and no distortion.



SZ51

SZ61

CONTENTS

Features	1-12
• SZX7 Optical Performance	• SZ61/SZ51 Optical Performance
• Ergonomic Design	• Illumination System
• Digital Imaging & Recording System	• Mounting System & Accessories
Specifications	13-14
SZX7 system diagram	15-16
SZ61/SZ51 system diagram	17-18
Dimensions	Back Cover



SZX7



SZ61TR

SZX7: The ergonomic design combined with high image quality enables users to work for long periods of time without becoming fatigued.

SZ61: Excellent optical performance with a zoom ratio of 6.7:1.
Model variations: SZ61TR (with trinocular tube) and
SZ61-60 (with 60 degree observation tube inclination).

SZ51: Versatile, cost-efficient, and ideal in all line inspection applications.

Improved Ergonomic Instrumentation Means Improved Work Performance

Ergonomic improvements to our stereo microscopes enable natural posture for each user, improving comfort even when working for long periods of time.

Work in Comfort with Our New Ergonomic Components

With the SZX7's ergonomic instrumentation, eyepiece height and angle can be easily adjusted to suit individual users. This reduces user fatigue, which leads to increased productivity and profitability.

7:1 Wide Zoom Ratio

With a magnification range of 8X–56X (using 1X objective/10X eyepiece), the SZX7 offers a maximum zoom ratio of 7:1. This zoom ratio enables most specimens to be observed at the appropriate magnifications.

Excellent Resolving Power

Superior quality objectives deliver accurate, high resolution images that show specimens in minute detail.

A Range of Objectives to Suit Every Specimen and Every Application

- Superior image flatness:

The DFPlan objective series accurately reproduces the original shape of the specimen.

- Long working distance (W.D.):

The objectives range from the SZX-ACH1X (90 mm W.D.) to the DFPL0.5X (198 mm W.D.). As a result, even specimen surfaces that are difficult to access can be easily observed.

- Ideal for high magnification:

The microscope delivers excellent image quality up to 336X, by combining a 2X objective with 30X eyepieces. Also available is an excellent apochromatic objective DFPLAPO1.25X, with a higher zoom range of 1X through 7X.



Galilean optics feature two (right/left) independent and parallel zoom optical paths to produce the focal point with one objective. The system enables high optical performance as well as functional modularity.



“ComfortView” Eyepieces for Greater Comfort and Faster Work

New ComfortView eyepieces feature pupil aberration control and appropriate positioning in the eye point for fast and comfortable observations.

Accurate Color Reproduction

The careful selection of lens surface coating and glass materials for the entire optical system make it possible to observe and document specimens with accurate color reproducibility.

Sharp, Clear, High-Contrast Images

The low, suppressed field curvature ensures that the shape of the specimen is accurately reproduced.

A Wide Variety of Observation Tubes and Intermediate Tubes Enable Operators to Obtain the Right Image

Various types of tubes are available, and they can be freely combined to create the ideal system for any application.



Aperture diaphragm unit / SZX-AS



1. 45 degree binocular head / SZX-BI45 2. Tilting trinocular head / SZX2-TTR
3. 30 degree trinocular head / SZX-TR30 4. Ergonomic Long Tilting Trinocular / SZX2-LTTR

Precise, Functional, and Compact—SZ61/SZ51

The SZ61/SZ51 incorporate the Greenough optical system and accomplish a range of practical observation and documentation functions in a compact design.

6.7:1 Wide Zoom Ratio

The SZ61's wide magnification range extends from 6.7 through 45X (using 10X eyepieces) with a zoom ratio of 6.7:1. The newly developed optical system enables fast, comfortable observations at the most appropriate magnification. The SZ51 has a magnification range of 8X through 40X (using 10X eyepieces) with a zoom ratio of 5:1.

Outstanding Depth of Focus and Flatness

The 10-degree angle convergence of the image forming path in the Greenough optical system delivers excellent image flatness with a deep depth of focus.

“ComfortView” Eyepieces for Greater Comfort and Faster Work

ComfortView eyepieces feature pupil aberration control and appropriate positioning in the eye point for fast and comfortable observations.

Accurate Color Reproduction

The glass material and surface coating on these objectives provide accurate specimen color reproducibility.

Sharp, Clear, High-Contrast Images

The low, suppressed field curvature ensures that the shape of your specimens is accurately reproduced.



The Greenough optical system has two zoom optical paths inclined at an inward angle. This enables a more compact microscope design while maintaining high performance.



Five Zoom Body Variations with High Performance

The SZ61 and SZ51 zoom bodies provide two different magnification ranges. They are available with an ergonomically designed 45-degree inclination tube for use on the standard stand. Models with a 60-degree inclination tube (SZ61-60/SZ51-60) are available for special applications where the zoom body has to be tilted for use with other equipment or mounted on a universal stand. For documentation purposes, Olympus also offers the SZ61TR, which incorporates a trinocular tube for easy attachment of digital and video cameras.

Wide Choice of Auxiliary Objectives

A wide choice of auxiliary objectives enable observations at magnifications from 2X to 270X and W.D. up to 350 mm to meet every application purpose.



Work Comfortably and Productively

Olympus is committed to making work easy, comfortable, and productive through leading-edge ergonomic designs. That means applying advanced technological methods to excellent operability, reducing factors that contribute to operator fatigue, and building in effective safety features like an electrostatic discharge (ESD) safe design.

Ergonomic Instruments Enable Natural Posture, Reduced Stress, and Increased Productivity

The ergonomic long tilting trinocular provides an optimized work position for individual users by bringing the microscope closer to the user, while the extendable eyepoint adjuster provides flexibility for users of different heights. The SZX series' ergonomic instruments reduce stress during observation by providing the most comfortable position for each user, increasing work efficiency.

Ergonomic Design Based on 3D CAD Analysis

The microscope body and stand feature precisely curved contours developed through careful 3D computer aided design (CAD) analysis. Key ergonomic features help to reduce fatigue in periods of long observation and include an all-round finish that's smooth to the touch.

Convenient Front-Access Operation

Improved ease of access to the most frequently used knobs and switches maximizes operator comfort and reduces back strain.

Precise Recall of Specific Magnification Settings via Integrated Click-Stop Mechanism (SZX7) or Zoom Knob Stopper (SZ61/SZ51)

Many inspection tasks require the use of the same zoom magnification setting to ensure consistent and comparable results. The integrated click-stop mechanism provides quick and easy access to this important function. The zoom knob stopper enables the user to accurately choose their desired magnification, and the setting in use is clearly displayed on the front control panel.

New Eyepiece Reduces Fatigue and Excludes Dust

This eyepiece features a pupillary aberration control mechanism whereby the image remains visible even if the operator's eyes move. This lessens operator fatigue in long duration observations. The unique eyepiece mounting design excludes dust particles and keep the eyepiece firmly in place ensuring clear images and an ergonomic eyepiece position.

ESD Safety Design

All microscope bodies and accessories are ESD-safe and are able to discharge static electricity from 1000 V down to 100 V in less than 0.2 seconds, protecting the equipment and preventing sample damage.



Extendable Eyepoint adjuster



LED Transmitted / Reflected Light Illumination Stand



Zoom handle



Click-stop mechanism (SZX7)



Zoom knob stopper (SZ61/SZ51)



Eyepiece lock



Ground wire connection (back side)

Olympus Light Solutions Maximize Visibility in Different Tasks

Olympus offers a range of light solutions perfectly tuned to the stereo zoom microscope's optical system to maximize the visibility of even minute characteristics.

The New LED Integrated Reflected/Transmitted Illumination Stand

The universal reflected/transmitted illumination stand brings together all the advantages of LED technology. It enables the simultaneous use of reflected and transmitted illumination, and can alter their respective intensities continuously and separately by means of convenient dials on the stand. The use of slim, ultra-bright LED's successfully integrates transmitted illumination in a slim 25 mm thick base that facilitates easy specimen access and manipulation. The complete microscope, including LED integrated stand, is lightweight, compact, and easy to carry.

Universal Reflected Illumination Systems

Fiber optic illumination systems offer excellent illumination quality and flexibility. Olympus offers a compact 6 W LED light source (SZ2-CLS) and a 100 W light source (LG-PS2*) for professional use. Homogeneous illumination can be achieved by a ring light. For special contrast effects on free form 3D shapes, Olympus offers a choice of single and double self supporting spot illumination fiber guides and precisely adjustable flexible fiber guides.

*An equivalent model may be offered in some areas.

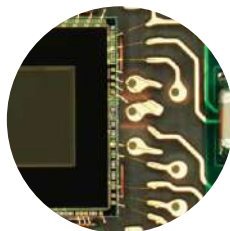

Homogeneous light

Transmitted Light Illumination Systems

For all transparent materials as well as for background illumination for the inspection of through holes, Olympus' choice of illumination stands ranges from simple brightfield/simple oblique (SZX2-ILLK) up to brightfield/darkfield (SZX2-ILLD) and brightfield/oblique Koehler (SZX2-ILLB) illumination models. Also available is a brightfield/oblique illumination attachment (SZ2-ILA) that can accommodate various light sources including a 100 W halogen lamp housing.

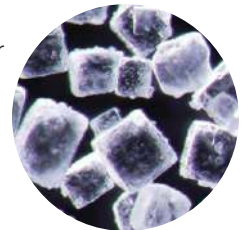

Darkfield light

Special Illumination Techniques

• Looking into holes

Olympus offers effective coaxial illuminators for the SZX7 (SZX2-ILLC10) and the SZ61/SZ51 (SZ2-ILLC) which direct the light through the microscope's optical axis onto the specimen.

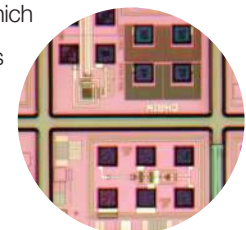

Coaxial light

• Mirrored Surfaces

The illumination of highly reflective specimens needs special techniques in order to avoid disturbing light reflections. For spot and ring light illuminators, as well as for coaxial illuminators, Olympus offers dedicated polarizing equipment which eliminates such light effects (LG-R66PL for ring light illumination).

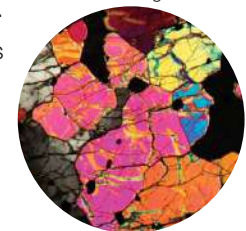

Polarized light



Flexible angle of LED light source



Homogeneous illuminations fiber optic systems



Intelligent LED ring illumination



White LED illumination unit



Making Stress in Transparent Materials Visible

Also available are simple and advanced transmitted illumination stands with polarizing equipment (SZX2-AN, SZX-POL, and SZ-POL2) for the efficient evaluation of tensions in transparent materials like plastic and glass. Their ease of use enables continuous, reliable production control of processes like injection molding.

The transmitted/reflected integrated LED illumination stand's slim body and easy operation enables quick observations in a comfortable posture.



Single illuminations fiber optic systems



Transmitted and coaxial illuminations with fiber optic systems



High power fiber optic illumination system

Digital Imaging



SZX7 in combination with DP73 digital camera system

High Resolution Digital Camera DP73

This outstanding 17.3-megapixel cooled digital camera with pixel-shift technology attains superior resolving power, sensitivity, and precise 14-bit (16384 steps) color fidelity. The DP73 is compatible with all light microscope observation methods and produces contrast-balanced images using a unique dynamic range technology. ISO1600 sensitivity delivers clear display even for faint fluorescence signals. A high-definition 1600 × 1200-pixel image can be displayed live at a rate of 15 frames-per-second without compression and images with a maximum 4800 × 3600-pixels can be instantly saved.



SZX7 in combination with DP27 digital camera system

Digital Camera DP27

This high-resolution, 5-megapixel color CCD camera provides optimal true color performance for all industrial applications and imaging techniques. The DP27 incorporates high speed progressive scanning with USB 3.0 connectivity.



DP22 digital camera mounting on the SZ61

High-speed, Compact Digital Camera DP22

This 2.8-megapixel color CCD camera can be used as a complete stand-alone model (no PC required). The control box incorporates the 12 most frequently used measurement functions for efficient inspection of industrial parts, providing smooth and intuitive operation via a touchscreen monitor or a mouse.

A Range of Accessories to Meet Your Needs

Easy Mounting with Other Equipment (Bonder and Prober Arms)

The SZX7, SZ61, and SZ51 are designed to be integrated into process equipment. Olympus offers various bonder and prober arms for all common brands.



1. B & L style bonder arm / SZ2-STB1 2. Bonder arm / SZ2-STB2 3. Bonder arm / SZ2-STB3
4. Prober arm / SZ2-STP 5. Arm for SZX stand /SZ2-ST5 6. Adapter for B & L bonder arm / SZ-BLAD



Ergonomic Low-Positioned Focus Handle and More Stage Adapters

With the focusing unit SZ2-FO, focus adjustment can be made while the user's hands are resting on the work surface. The action of focusing requires minimal force as the microscope zoom body does not need to be moved. This enables prolonged work on difficult samples without fatigue. There are also more stage adapters, including the cup stage SZH-SC which gives the specimen a slant angle up to 30 degrees from the level.



Various Universal Stands

A variety of universal stands are available for the observation of large specimens. No matter how big the samples are or how much they vary in size, Olympus has the right choice of stands to suit any requirements.



SZX7+SZ2-STU2



SZ61+SZ2-STU3

SZX7 specifications

Item	Specifications				
Zoom microscope body SZX-ZB7	Zoom drive: Horizontal knob system Click stop for each zoom magnification: ON-OFF switching possible Zoom ratio values: 7:1 (0.8X to 5.6X) Zoom magnification indication: 0.8, 1, 1.25, 1.6, 2, 2.5, 3.2, 4, 5, 5.6 Objective mounting: Screw mounting into thread Lead-free materials used				
Aperture iris diaphragm control: The AS unit (SZX-AS) is mountable					
Observation tube SZX-BI45 SZX2-TTR SZX2-TR30 SZX2-LTTR	SZX-BI45	SZX2-TTR	SZX2-TR30	SZX2-LTTR ^{*1}	
	Binocular tube View inclination angle 45° Lead-free materials used	Tilting binocular (trinocular) tube View tilting angle 5° to 45°	Trinocular tube View inclination angle 30° Light path selection: 2 steps (Binocular 100%, Video 50%/Binocular 50%)	Ergonomic Long Tilting Trinocular View tilting angle 5° to 45°, Light path selection: 2 steps (Binocular 100%, Video 50%/Binocular 50%)	
Interpupillary distance adjustable range	52 to 76 mm Eyepiece clamping knob provided			57 to 80 mm Eyepiece clamping knob provided	
Extendable Eyepoint adjuster	SZX2-EEPA: Height adjustment range: 30–150 mm, (with a scale attached)				
Stand SZ2-ST SZ2-ILST	SZ2-ST	SZ2-ILST			
	Standard stand	LED reflected/transmitted illumination stand			
	Frame installation	Mounting diameter 76 mm			
	Focusing adjustment	Knob rotation tension adjustment Focusing stroke 120 mm			
	Stage plate	SZ2-SPBW (Black & white) SP-C (Glass clear transparent)	The dedicated glass plate in 100 mm dia. included		
Light source	Compact light guide illuminator (SZ2-CLS) mountable (option) Transmitted light illumination attachment (SZ2-ILA) mountable (option)	Transmitted illumination: LED Reflected illumination: LED Average LED life span: 6000 hrs. Input rating: 100–120 V/200–240 V~0.15/0.1 A, 50/60 Hz			
Objectives	Model		Working distance		
	DFPL0.5X-4*2 DFPL0.75X-4 DFPLAPO1X-4 SZX-ACH1X DFPLAPO1.25X SZX-ACH1.25X-2 DFPL1.5X-4 DFPL2X-4 All objectives: Lead-free materials		171 mm 116 mm 81 mm 90 mm 60 mm 68 mm 45.5 mm 33.5 mm		
Eyepieces	"ComfortView" WHSZ series All eyepieces: Lead-free materials				
Weight	Configuration 1	4,360 g	5,400 g	5,200 g	5,300 g
	Configuration 2	5,160 g	6,200 g	6,000 g	6,100 g

*1 SZX2-LTTR: intermediate magnification is 1.25X.

*2 The SZ2-ET auxiliary sleeve is required when the SZ2-ST/ SZ2-ILST is used.

Configuration 1: SZX-ZB7 + DFPLAPO1X-4 + individual observation tube + WHSZ10X-H (2) + SZ2-ST

Configuration 2: SZX-ZB7 + DFPLAPO1X-4 + individual observation tube + WHSZ10X-H (2) + SZ2-ILST

SZ61/SZ51 specifications

Item	Specifications				
Microscope body SZ61 SZ61-60 SZ61TR SZ51 SZ51-60	Magnification	0.67X to 4.5X		0.8X to 4X	
	Zoom ratio	6.7:1		5:1	
	Working distance	110 mm			
	Tube inclination angle	45°	60°	45°	60°
	Interpupillary distance adjustment	Left/right interlocked Adjustment range: 52 to 76 mm (using the WHSZ10X eyepieces)			
	Video camera adaptability	—	C-mount (0.5X built in)	—	
	Zoom adjustment knob	Left/right single-shaft horizontal knob Interpupillary distance high/low magnification stopper incorporated.			
	Optical components	Lead-free materials used			
	Auxiliary objective	Mounting by screwing into the thread at the bottom of frame (M48 thread X0.75)			
Eyepiece	"ComfortView" WHSZ series Lead-free materials used				
Stand SZ2-ST SZ2-ILST	SZ2-ST	SZ2-ILST			
	Standard stand	LED reflected/transmitted illumination stand			
	Frame installation	Mounting diameter: 76 mm			
	Focusing adjustment	Focusing stroke: 120 mm			
	Stage plate	SZ2-SPBW (Black & white for anti-ESD) SP-C (Clear glass plate)	The dedicated glass plate in 100 mm dia. included		
Light source	Compact light guide illuminator (SZ2-CLS) mountable (option) Transmitted light illumination attachment (SZ2-ILA) mountable (option)	Transmitted illumination: LED Reflected illumination: LED Average LED life span: 6000 hrs. Input rating: 100–120 V/200–240 V ~0.15/0.1 A, 50/60 Hz			
Weight	Zoom body only	1,300 g	1,500 g	1,300 g	
	Configuration 3	3,520 g	3,720 g	3,520 g	

Configuration3: Zoom body + WHSZ10X-H(2) + SZ2-ST

“ComfortView” WHSZ eyepiece

	FN	Diopter adjustment	Reticle	Focal magnification
WHSZ10X	22	—	N.A.	—
WHSZ20X	12.5	—	N.A.	—
WHSZ10X-H	22	-8+5	Yes*3	—
WHSZ15X-H	16	-8+5	Yes*3	—
WHSZ20X-H	12.5	-8+5	Yes*3	1.3X
WHSZ30X-H	7	-8+5	Yes*3	2X

*3 Applicable reticle size: 24 mm diameter, 11.5

Auxiliary objective for SZ61/SZ51

	Working distance (mm)
110ALK0.3X	250–350
110ALK0.4X	180–250
110AL0.5X	200
110AL0.62X	160
110AL0.75X	130
110AL1.5X	61
110AL2X	38

SZX7 optical performance**4

Eyepiece	WHSZ10X-H WHSZ10X		WHSZ15X-H		WHSZ20X-H WHSZ20X		WHSZ30X-H	
	22		16		12.5		7	
Objective	Total magnification	Field of view (mm)	Total magnification	Field of view (mm)	Total magnification	Field of view (mm)	Total magnification	Field of view (mm)
0.5X	4X–28X	55–7.8	6X–42X	40.0–5.7	8X–56X	31.3–4.5	12X–84X	17.5–2.5
0.75X	6X–42X	36.7–5.2	9X–63X	26.7–3.8	12X–84X	20.8–3.0	18X–126X	11.7–1.7
1X	8X–56X	27.5–3.9	12X–84X	20.0–2.9	16X–112X	15.6–2.2	24X–168X	8.8–1.3
1.25X	10X–70X	22–3.1	15X–105X	16.0–2.3	20X–140X	12.5–1.8	30X–210X	7.0–1.0
1.5X	12X–84X	18.3–2.6	18X–126X	13.3–1.9	24X–168X	10.4–1.5	36X–252X	5.8–0.83
2X	16X–112X	13.8–1.9	24X–168X	10.0–1.4	32X–224X	7.8–1.1	48X–336X	4.4–0.63

** SZX2-LTTR: Intermediate magnification is 1.25X SZX2-ILLC10: Intermediate magnification is 1.5X

SZ61/SZ51 optical performance

Microscope body	Zoom magnification	WHSZ10X-H WHSZ10X		WHSZ15X-H		WHSZ20X-H WHSZ20X		WHSZ30X-H	
		FN 22		FN 16		FN 12.5		FN 7	
		Total magnification	Field of view (mm)	Total magnification	Field of view (mm)	Total magnification	Field of view (mm)	Total magnification	Field of view (mm)
SZ61	0.67X	6.7	32.8	10.1	23.9	13.4	18.7	20.1	10.4
	1X	10	22	15	16	20	12.5	30	7.0
	2X	20	11	30	8	40	6.3	60	3.5
	3X	30	7.3	45	5.3	60	4.2	90	2.3
	4.5X	45	4.9	67.5	3.6	90	2.8	135	1.6
SZ51	0.8X	8	27.5	12	20	16	15.6	24	8.8
	1X	10	22	15	16	20	12.5	30	7.0
	2X	20	11	30	8.0	40	6.3	60	3.5
	3X	30	7.3	45	5.3	60	4.2	90	2.3
	4X	40	5.5	60	4.0	80	3.1	120	1.8

No auxiliary objective is attached

Light guide

Item		Specifications				
Model		SZ2-CLGR	SZ2-CLGDI	SZ2-CLGDF	SZ2-CLGSI	SZ2-CLGSF
Tube type		Flexible tube	Interlocked tube	Flexible tube	Interlocked tube	Flexible tube
Total length		900 mm	580 mm	691 mm	570 mm	663 mm
Fiber	Type (Material)	Multicomponent glass				
Bundle diameter	Input end	ø6 mm	ø5 mm	ø5 mm	ø3.5 mm	ø4.5 mm
	Output end	ø2.4 × 6 mm	ø3.5 mm	ø6.4 mm	ø3.5 mm	ø4.5 mm
Minimum bending radius		60 mm	60 mm	25 mm	60 mm	25 mm

Compact light guide illuminator SZ2-CLS

Item	Specifications
Dimensions (W × D × H)	107 × 61 × 114 mm
Weight	Approx. 0.35 kg (Main body)
Color temperature	Approx. 5,600 K
Light intensity adjustment	Continuous
LED life time	Approx. 50,000 hours (The light intensity is reduced by 70%.)
Cooling	Convection
Ambient temperature	5 to 40 °C (41 to 104 °F)
Operating voltage	AC100–240 V (AC adapter)
Power consumption	Max. 6 W

LED ring illumination SZX2-ILR66

Item	Specifications
Features	4-part LED ring illumination 4-part independent ON/OFF available
Illumination	Operation modes : rotary, mirror ESD compatible, Clean class 1
Light source	17-step light intensity adjustable AC100–240 V
Others	SZX-LGR66/SZ-LGR66 adapters are required for SZX7/SZ61 respectively

SZX7 System Diagram

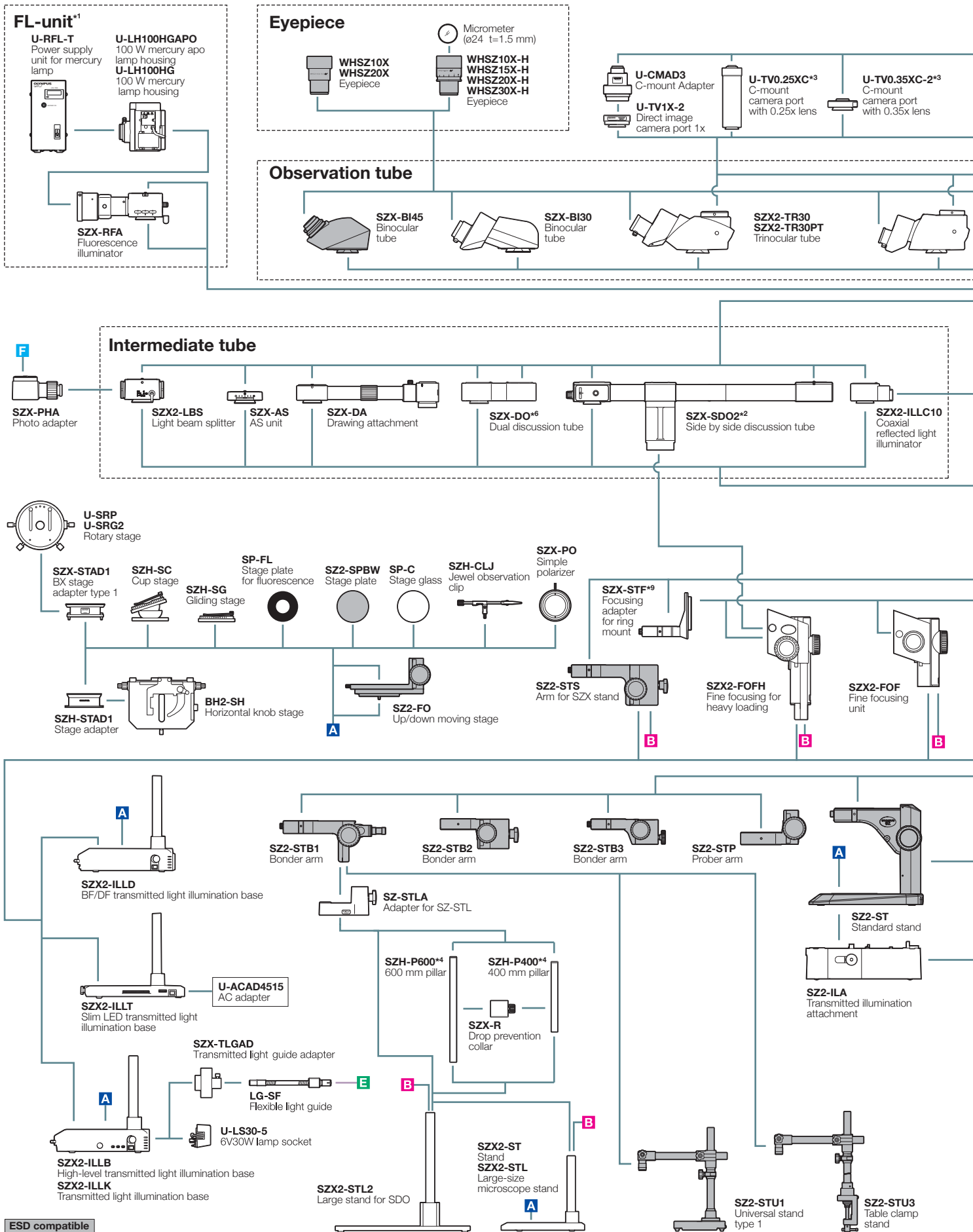

^{*1} Focusing unit (SZX2-FOF, SZX-FOFH or SZX-FO) and SZX-STF are required when mounting fluorescent unit. ^{*2} SZX2-FOFH and SZX2-STL2 are required when using SZX-SDO2.
^{*3} Please contact your nearest Olympus dealer for applicable cameras. ^{*4} SZH-P400 and SZH-P600 can be attached to the transmitted light illuminators. ^{*5} Equipped to SZX2-ILLC10.

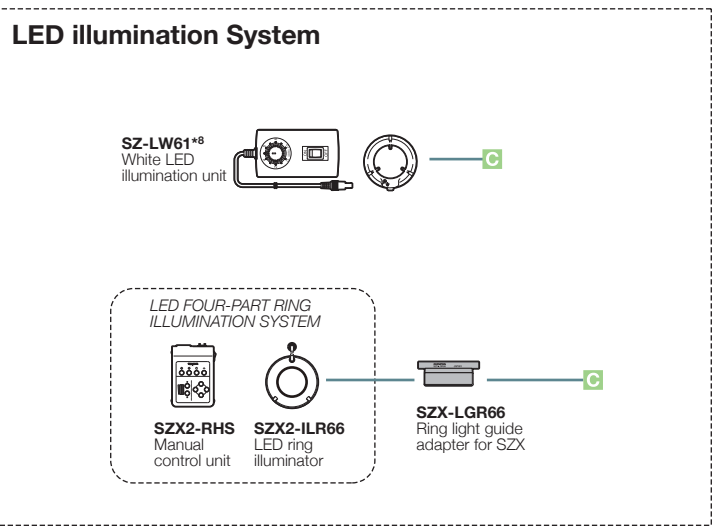
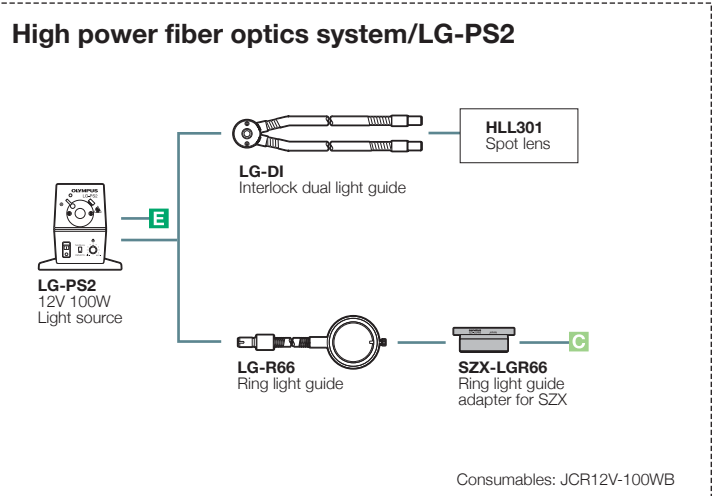
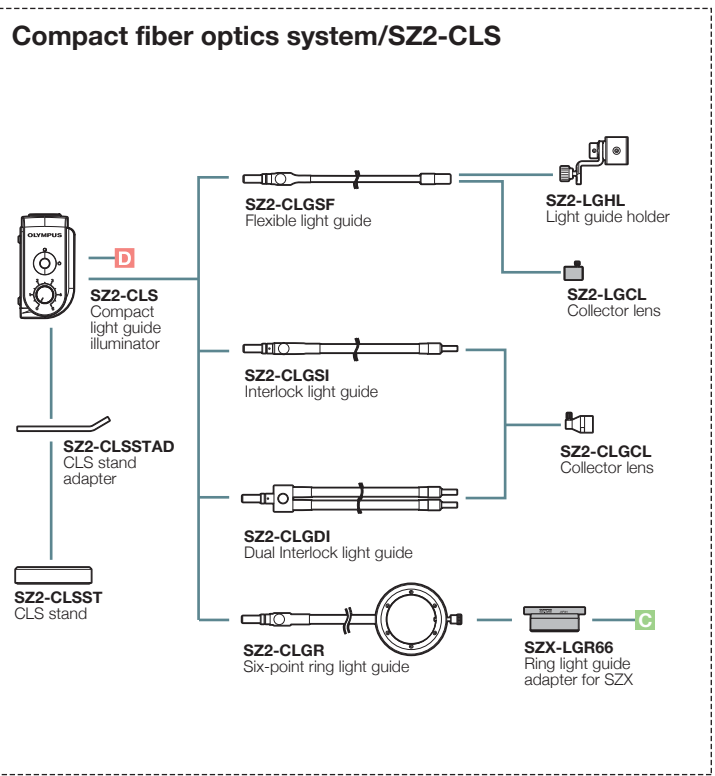
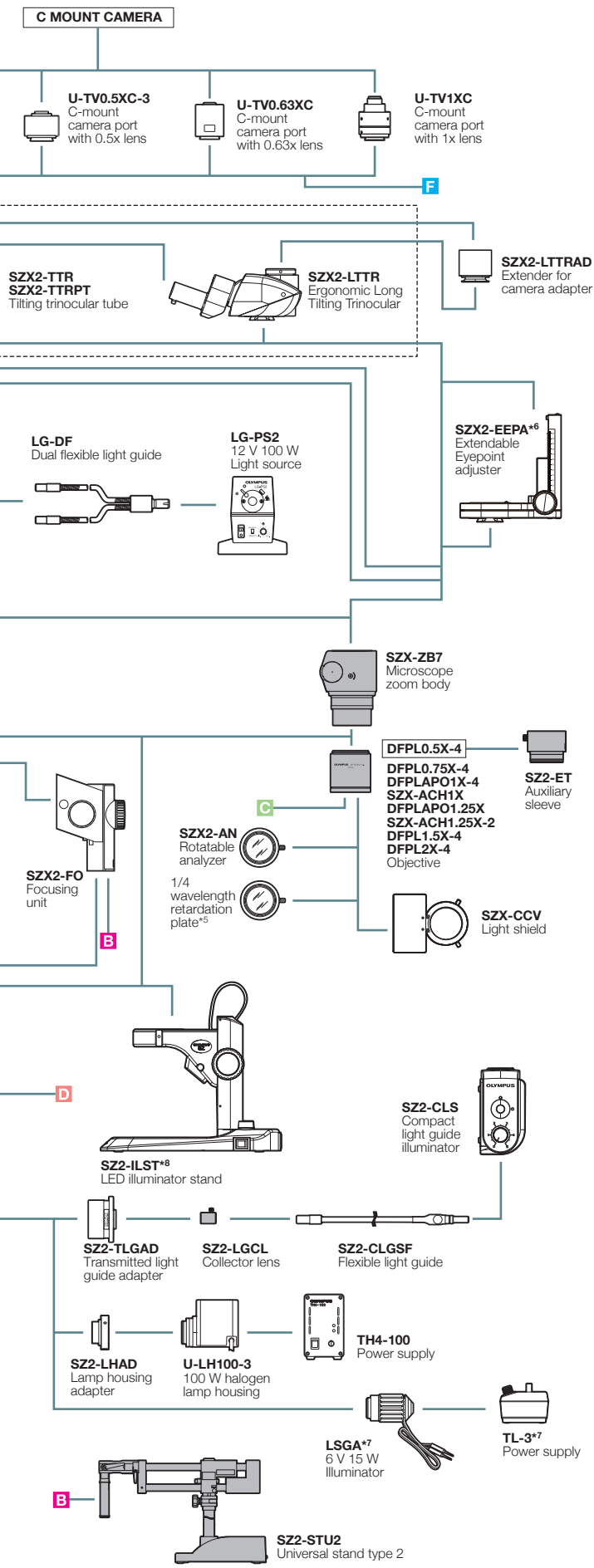

*6 Please contact your nearest Olympus dealer for applicable combination. *7 Not available in some areas. *8 SZ-LW61 cannot be combined with SZ2-ILST.
 *9 SZX-ACH1.25X and DFPLA01.5X-4 cannot be combined with SZX-STF.

SZ61/SZ51 System Diagram

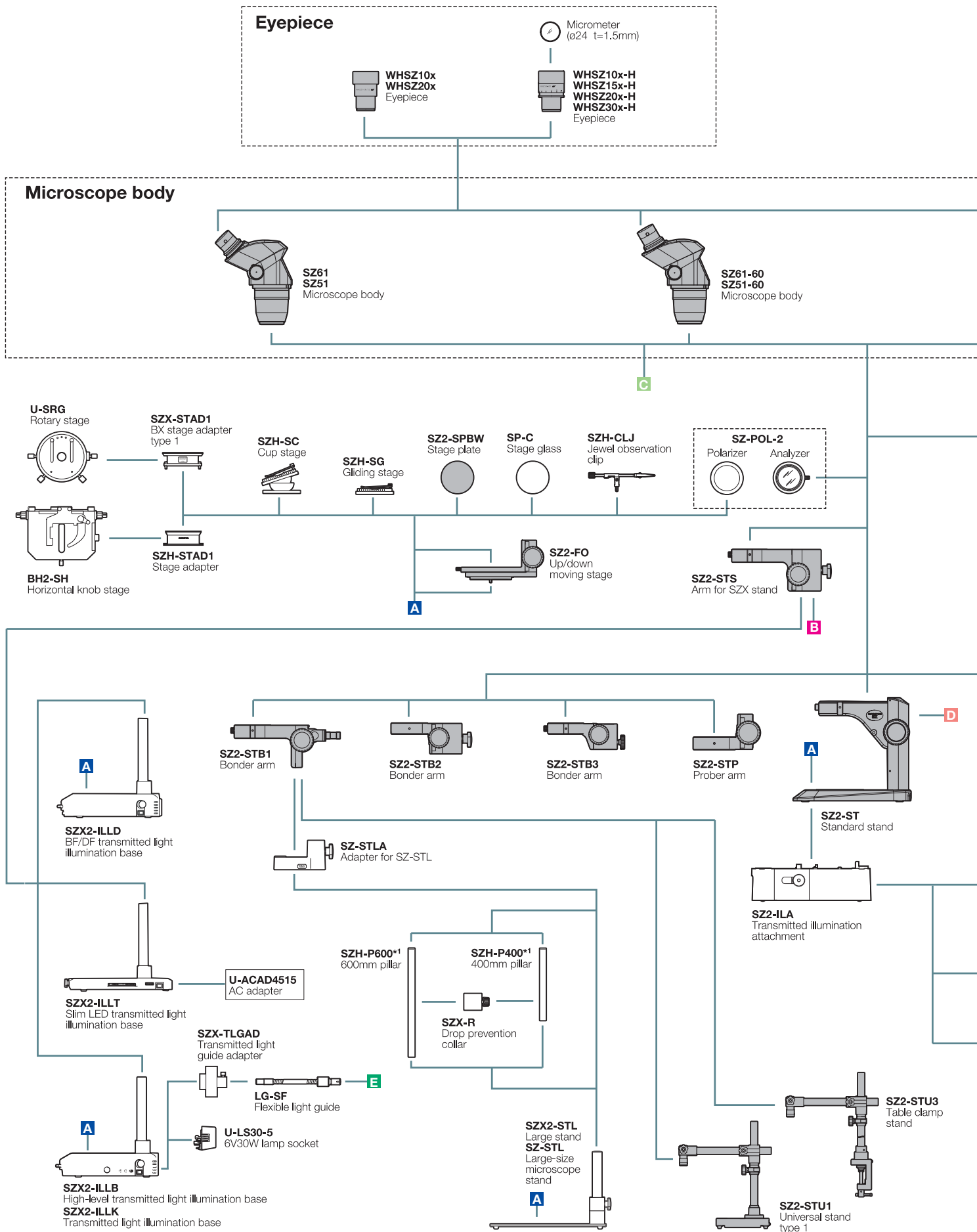

ESD compatible

*1 SZH-P400 and SZH-P600 can be attached to the transmitted light illuminators. *2 For information about configurable illumination base or stand, contact your nearest Olympus dealer. *3 Made to order. *4 Not available in some areas.

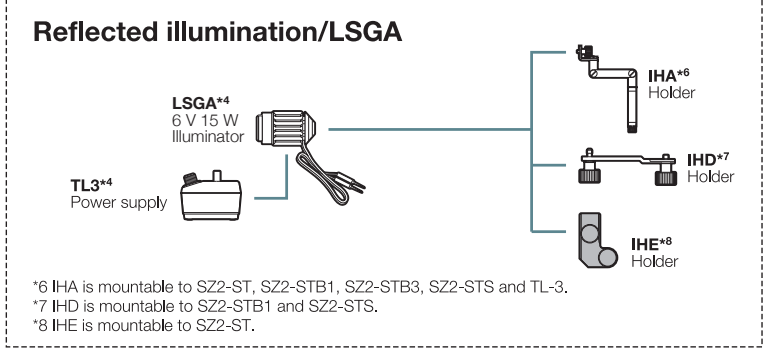
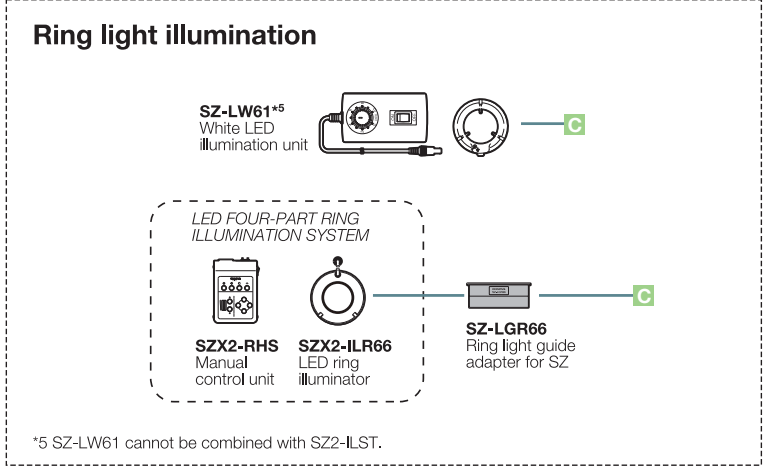
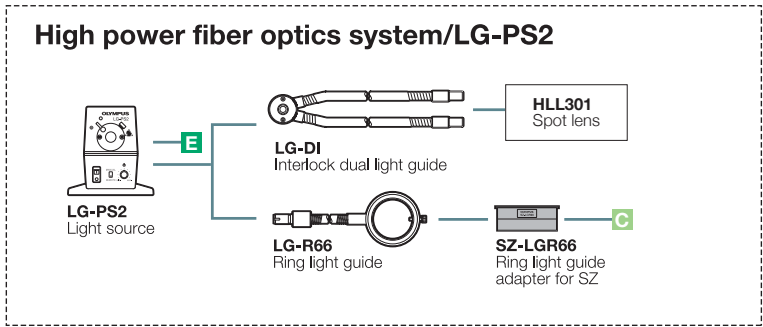
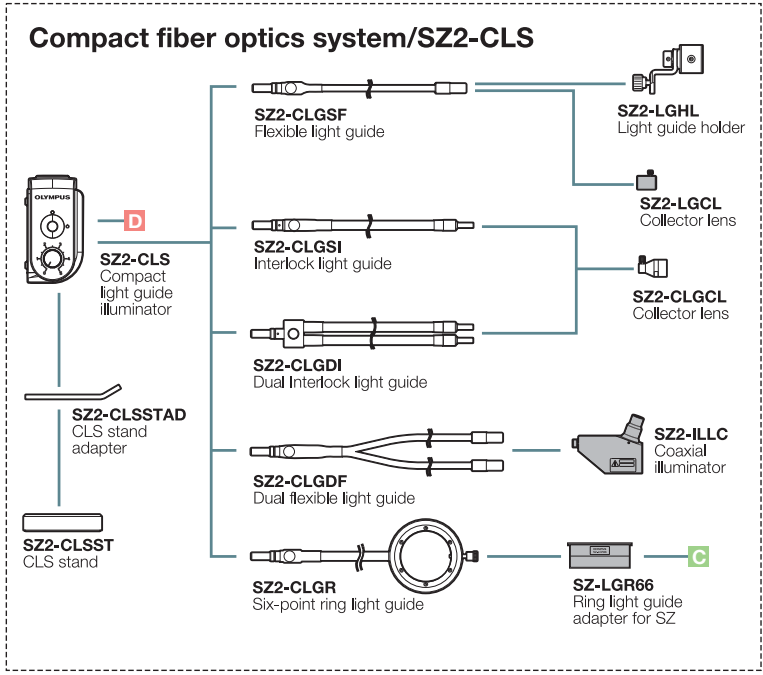
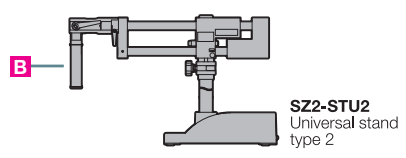
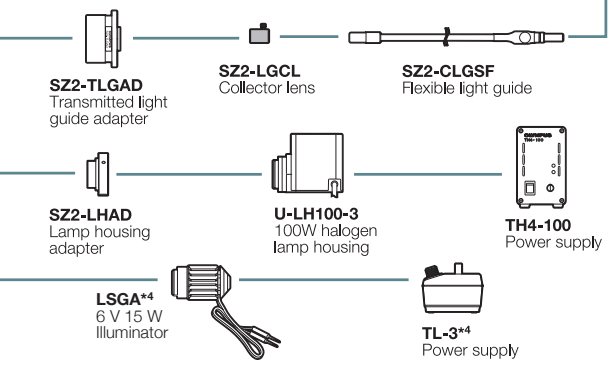
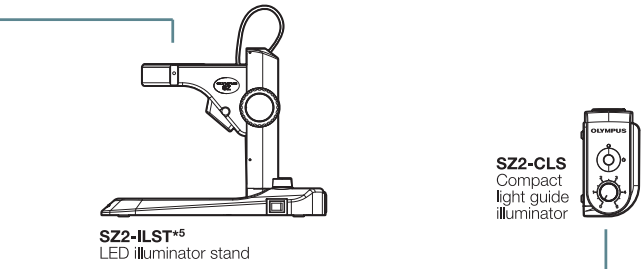
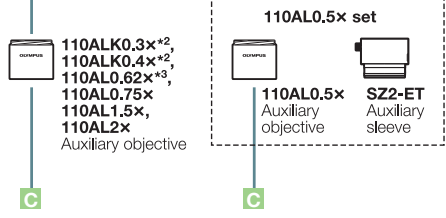
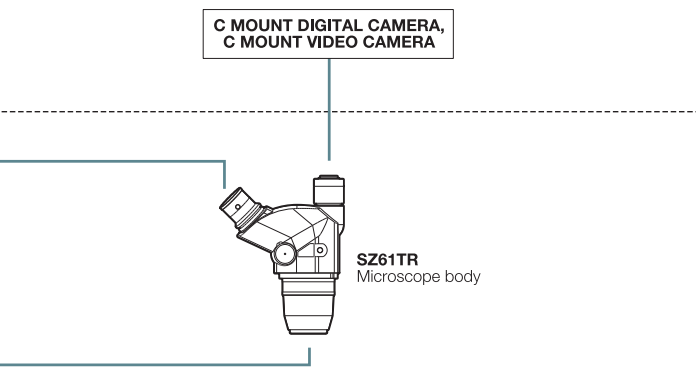

SZX7 dimensions

(Unit : mm)

SZX7

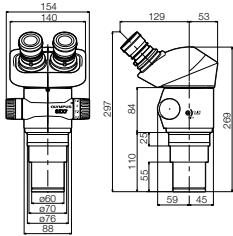

SZX7+SZ2-ST

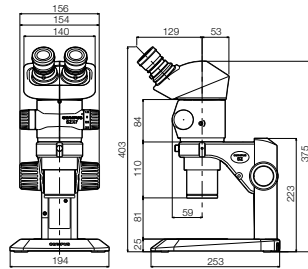

SZX7 (SZX2-TR30 configuration) +SZ2-ILST

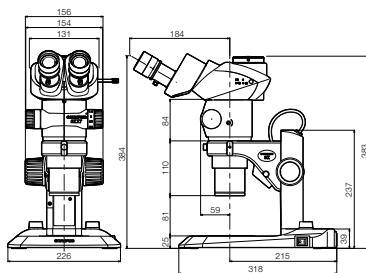

SZ61/SZ51 dimensions

(Unit : mm)

SZ61/SZ51

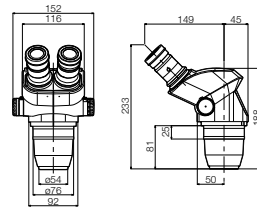

SZ61-60/SZ51-60

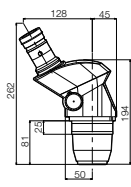

SZ61TR

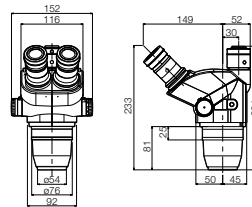

SZ61+SZ2-ST

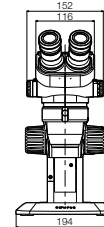

SZ51+SZ2-ST

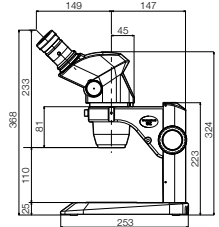

www.olympus-ims.com

OLYMPUS[®]

For enquiries - contact
www.olympus-ims.com/contact-us

OLYMPUS CORPORATION
Shinjuku Monolith, 2-3-1 Nishi-Shinjuku, Shinjuku-ku, Tokyo 163-0914, Japan
OLYMPUS EUROPA SE & CO. KG
Wendenstrasse 14-18, 20097 Hamburg, Germany
OLYMPUS SCIENTIFIC SOLUTIONS AMERICAS CORP.
48 Woerd Avenue, Waltham, MA 02453, U.S.A.
OLYMPUS MEDICAL SYSTEMS INDIA PRIVATE LIMITED.
102-B, First Floor, Time Tower, M.G. Road, Gurgaon 122001, Haryana, INDIA

OLYMPUS (CHINA) CO., LTD.
10F, K. Wah Centre, 1010 Hual Hai Road (M), Xuhui District, Shanghai, 200031 P.R.C.
OLYMPUS KOREA CO., LTD.
8F Olympus Tower, 446 Bongeunsa-ro, Gangnam-gu, Seoul, 06153 Korea
OLYMPUS AUSTRALIA PTY. LTD.
3 Acacia Place, Notting Hill VIC 3168, Australia
OLYMPUS SINGAPORE PTE LTD.
491B River Valley Road, #12-01/04 Valley Point Office Tower, Singapore 248373

- OLYMPUS CORPORATION is ISO14001 certified.
- OLYMPUS CORPORATION is ISO9001 certified.
- Illumination devices for microscope have suggested lifetimes. Periodic inspections are required. Please visit our web site for details.

- All company and product names are registered trademarks and/or trademarks of their respective owners.
- Images on the PC monitors are simulated.
- Specifications and appearances are subject to change without any notice or obligation on the part of the manufacturer.